

PŮDORYS (S = 1 / 50)

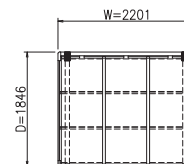

ČELNÍ POHLED (S = 1 / 50)

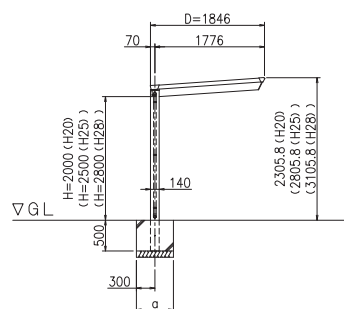

ŘEZ (S = 1 / 50)

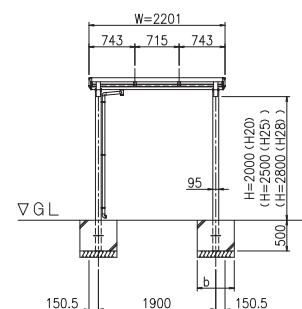

ZÁKLADY - SLOUPY (S = 1 / 50)

► ODTOKY / OKAPY

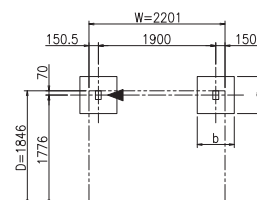

ZÁKLADY - MÍRY

dlouhodobé zatížení (KN/m ²)	a (mm)	b (mm)
50	700	700
100	600	600