

PŮDORYS (S = 1 / 50)

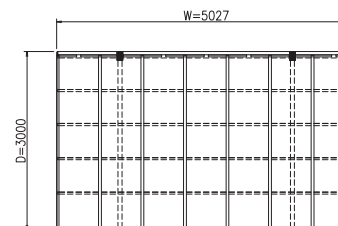

ČELNÍ POHLED (S = 1 / 50)

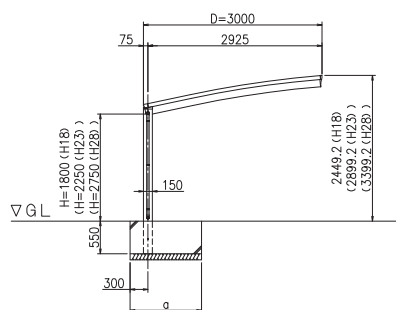

ŘEZ (S = 1 / 50)

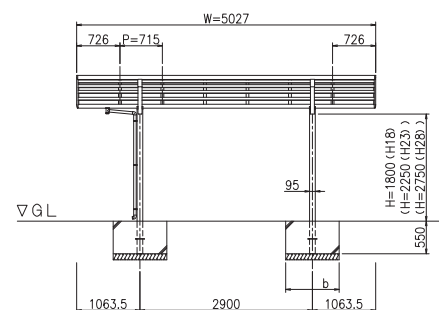

ZÁKLADY - SLOUPY (S = 1 / 50) ► ODTOKY / OKAPY

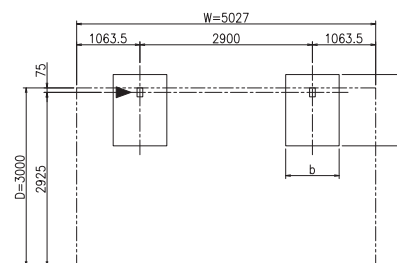

ZÁKLADY - MÍRY

dlouhodobé zatížení (KN/m ²)	a (mm)	b (mm)
50	1350	1000
100	1200	900