

TF1MA-C-15.10S-L

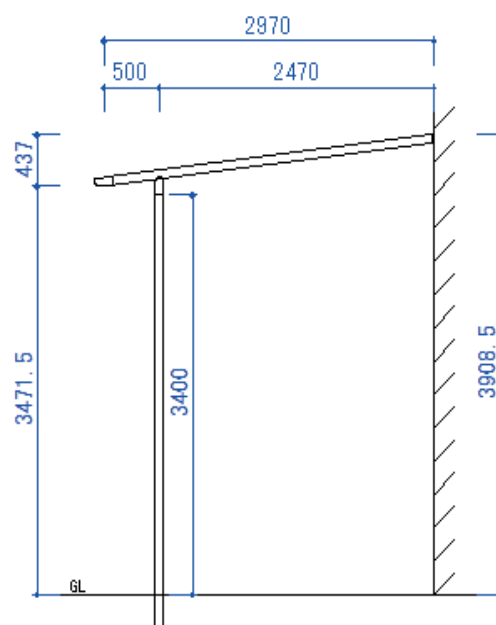
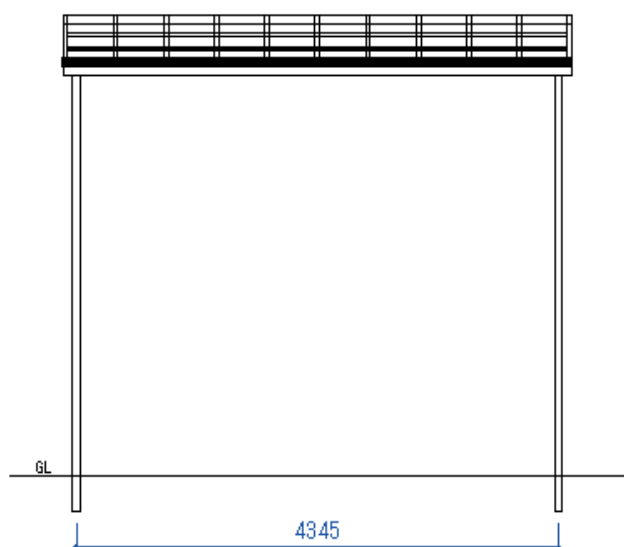
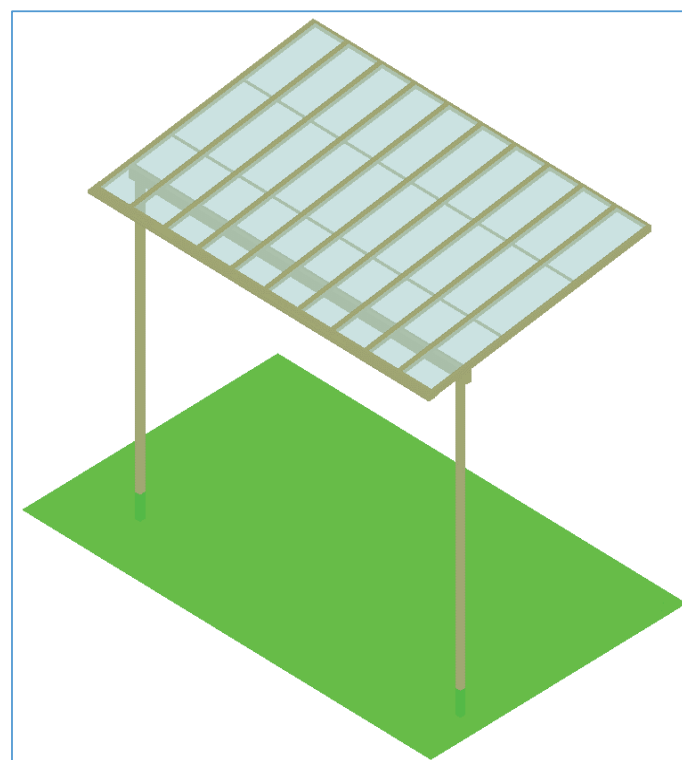
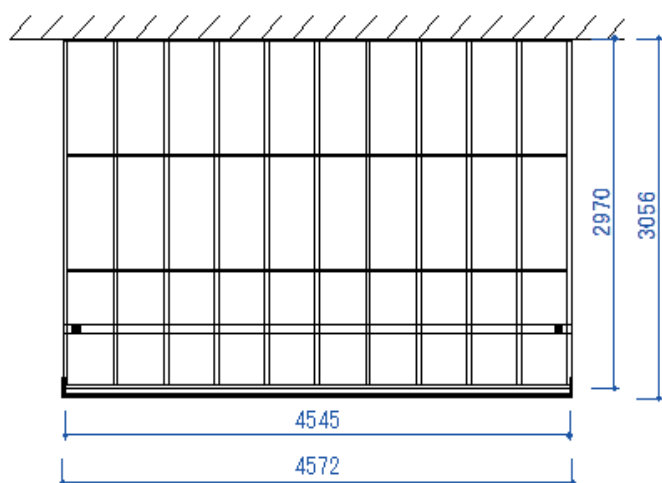

VYSVĚTLIVKY:
Plán hýbání sloupových základů v bočním rámu max. 500 mm.