

Technický výkres / Terasa TF1MA-C-24.10C-L

TF1MA-C-24.10C-L (12.10+12.10 Connect)

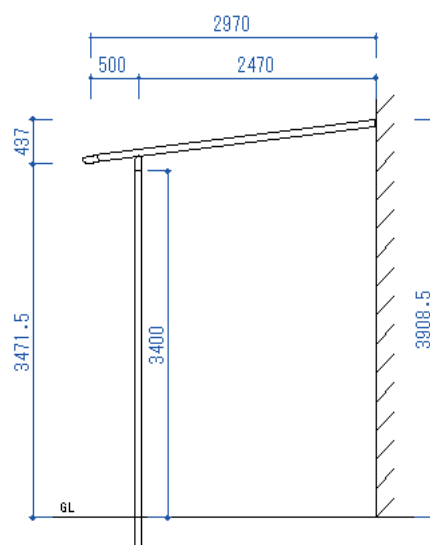
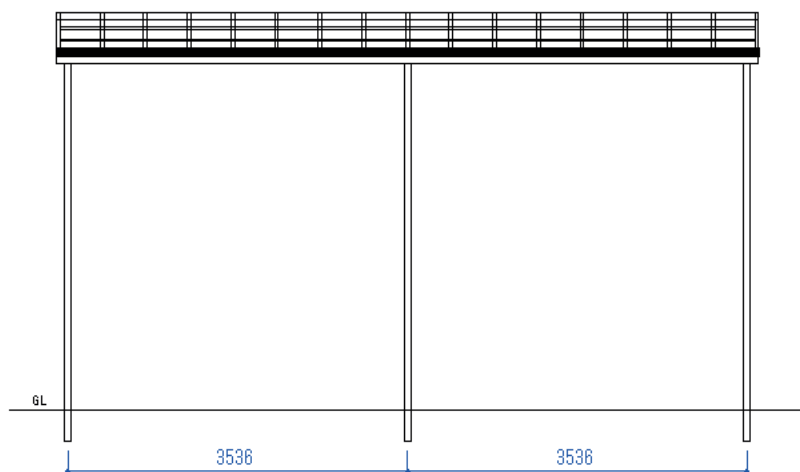
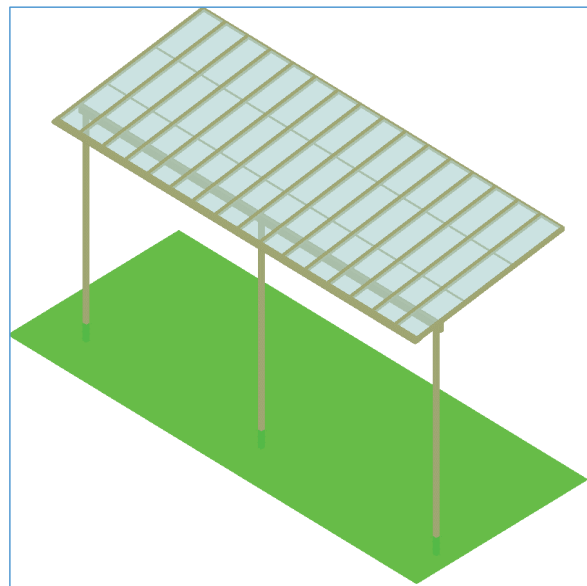
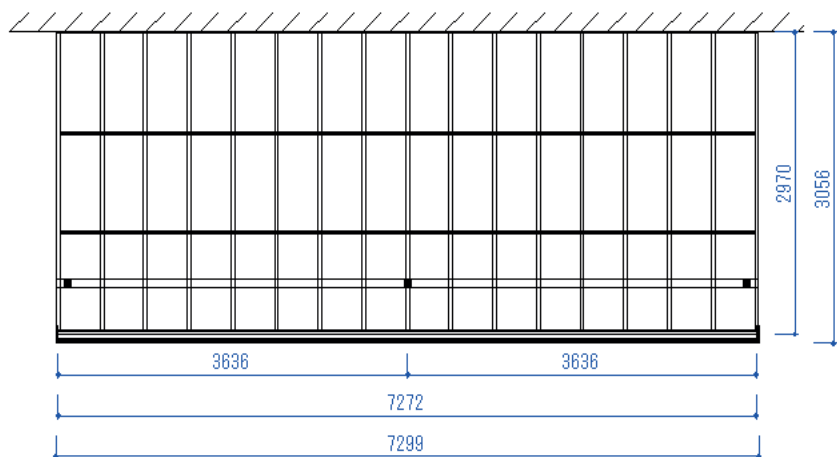

VYSVĚTLIVKY:
Plán hýbání sloupových základů v bočním rámu max. 500 mm.